



CLEAR ADVANTAGE LIGHTING

LIGHT + MEMPHIS

LOOKBOOK

Artemide



ALPHABET OF LIGHT



ARRIVAL



LA LINEA



GOPLE



DISCOVERY

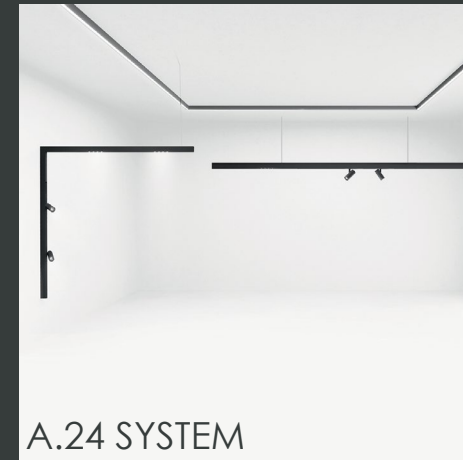

A.24 SYSTEM



CALIPSO

TARGETTI

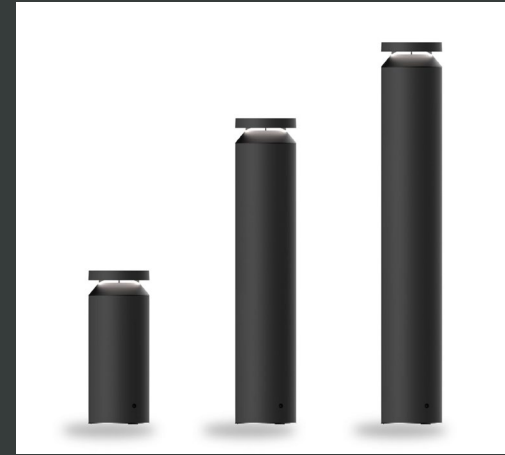

MR. BO



ZEDGE



BULLETO

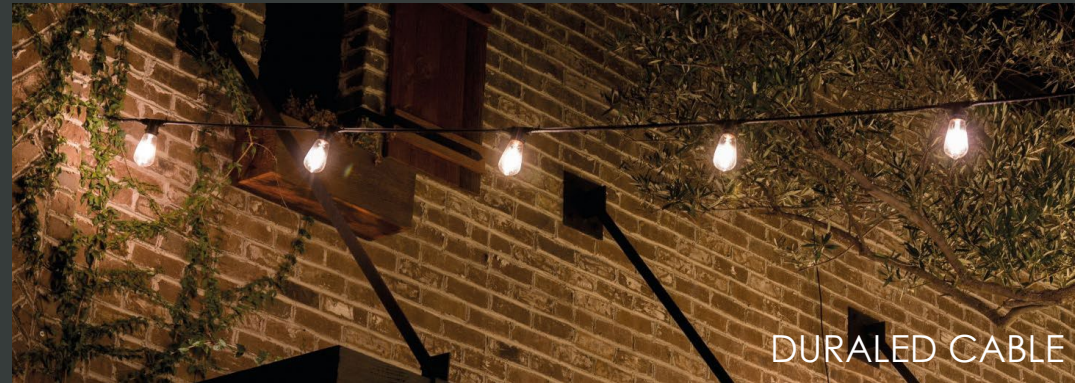

dodo



SIMPLELINE

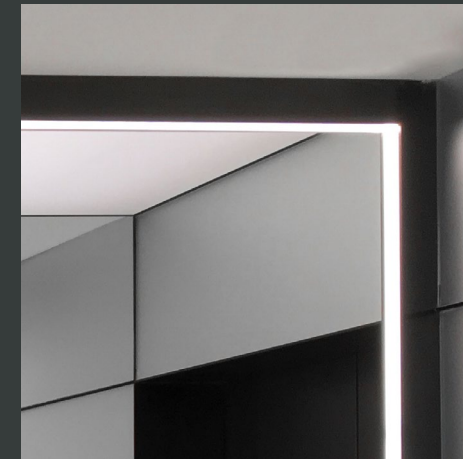

LIFTLINE

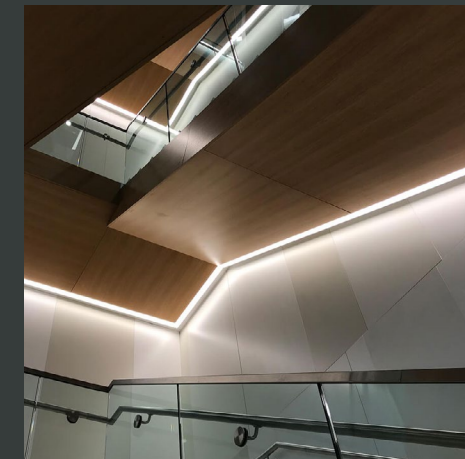

HARDLINE



MIRRORLINE



CABINETLINE



EXTERIOR HARDLINE

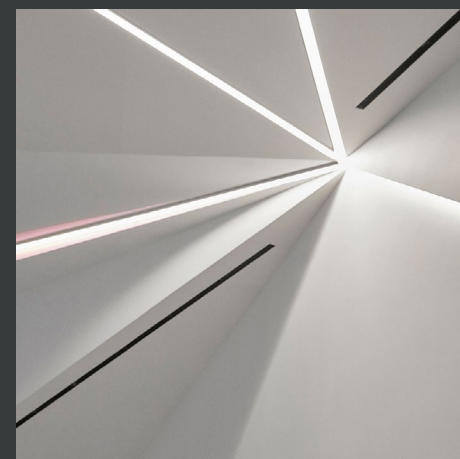

GRIDLINE



FINELINE 58



ti+ACT

a · light

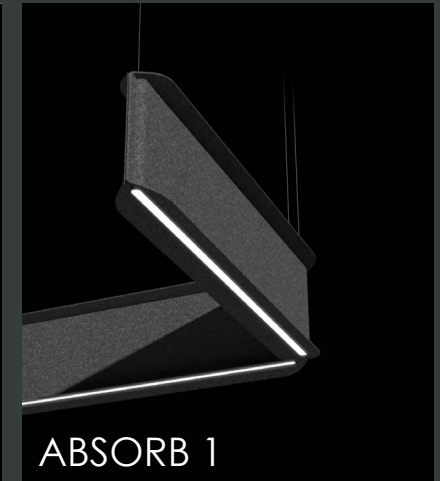
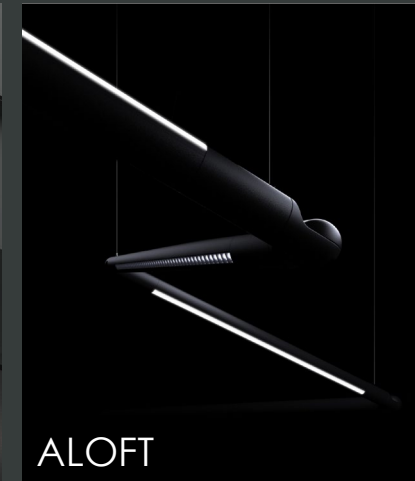
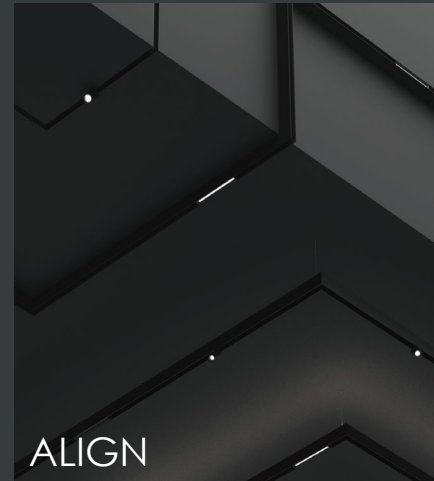

EUREKA

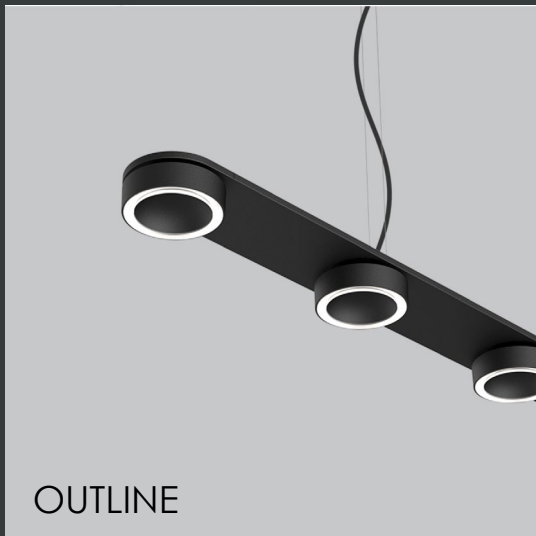

EUROfase

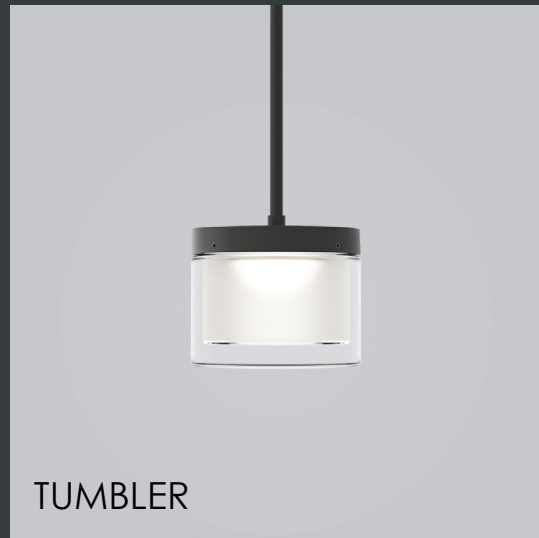
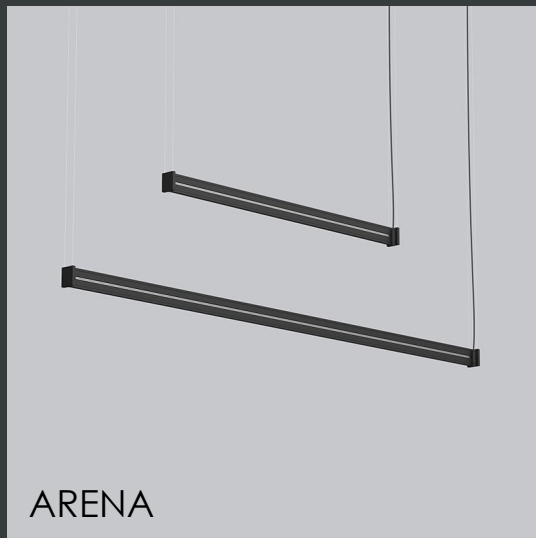



vode



CONTROL TRACK SURFACE



CONTROL TRACK RECESSED



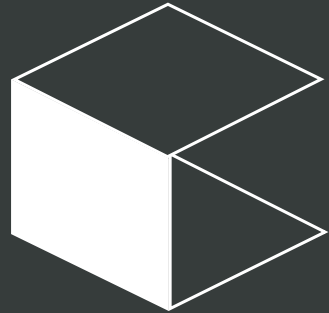

COOLEGE



FABRILUM LUMINAIRE



ACOUSTIC BENEFITS

USAI Lighting



BEVELED MINI BASIC PANCAKE

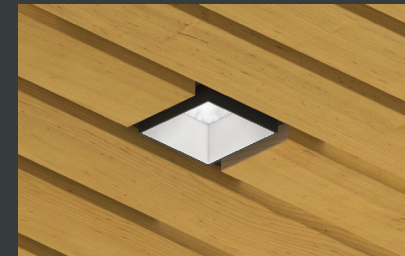

ARMSTRONG CEILING INTEGRATIONS



SPECIALTY ILLUMINATION SOLUTIONS



LITTLEONES MICRO DOUBLES

LUX
dynamics



WAVE+ SERIES



IK10+



LINE SERIES

inter•lux



PRO TOOLS 60 LINEAR



PRO TOOLS DOWNLIGHT

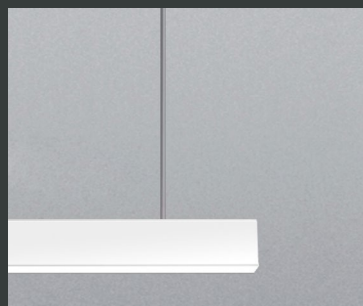

20 LINEAR DELUXE



PRO TOOLS WALL GRAZE



XENIA



ARCHILINE



PERISKOP



QUANTUM FIXED



DIRIGO

LEDRA brands



COBRA FLEX



SKYLINE



GX15



LX



DIMENSION



BETA

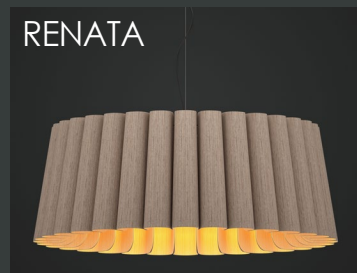

RENATA



DEEP REGRESS

Acuity Brands



PROPER

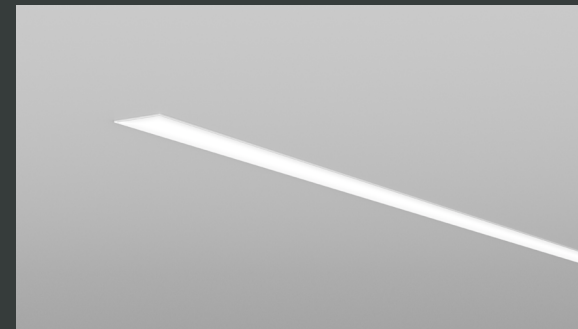

SLOT 1 RECESSED



UP/DOWN CYLINDER

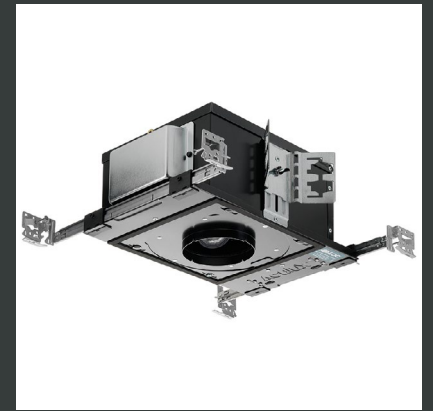

AX3

SternbergLighting

LUX ILLUMINAIRE



LU760 LARGE LUNARIA



1730 LED LARGE VILLA



FL300 LED FLIGHT BOLLARD



FLKs.4



AX.5



TORR.5



LNXX

ALW



SERENE



LUMA



HBeam 1.25



CRESCENT MOONRING



SUPERPLANE 4

SPILIGHTING



ECHO BLADE



ECHO EXPANSE

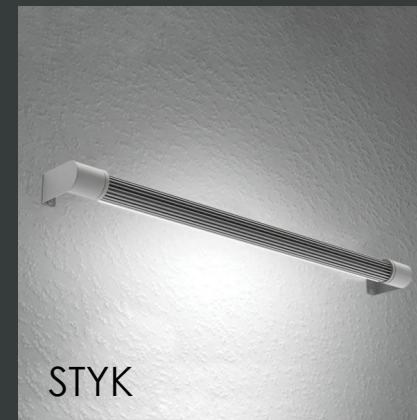

STYK



ZYNN LINES & ARCS



PAVO EXTERIOR



PAVO SQUARE